











LMB "G" Series / Linear weigher 1 - 6 Lines

 304 Stainless Steel	 Capacity 1.8 L
 Modular System	 Speed / dpm 8 - 60 (*)
 IP- 65 Protection	 Mains Power
 Hygienic Design	 You Tube Video Available
 Drawing Available	 Siemens PLC

(*) Depending on number of lines & type of product



Online Enquiry



LMB-04 " G " view (4 lanes sample)



Sample packages



Front view (4 lanes sample)



Rear view (Modular Design)

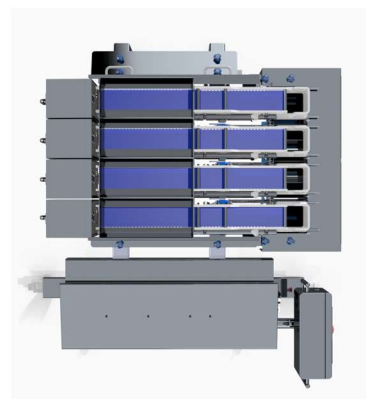

Top view (4 lanes sample)

The **SERMAX® LMB "G"** Scales range has been designed for the medium weights dosing and wider conveyor belts improving hygiene and safety within the food weighing and filling environment of sticky and fragile products, whilst maintaining the required high level of accuracy. Key features include:

- | | | |
|-------------------|----------------------------|--------------------------------|
| + Hygienic Design | + Remote connection | + Direct filling to trays/cups |
| + FDA components | + Mobile support | + Overweight rejection |
| + Easy to clean | + Configurable line offset | + Mixing of products |

